



YASKAWA

AC Drive for Fans, Pumps, HVAC E1000 Series

400V Class: 3.7 to 355 kw (5 to 473 HP)

E



The Green Inverter



ISO 9001 Quality Management Certification
ISO 14001 Environmental Management Certification

E Super Energy Saving

High Efficiency driven Induction Motor

Theoretical Maximum Energy Saving Operation

With lighter load, the efficiency tends to be lower. Under energy-saving control operation, it helps to improve the efficiency up to the theoretical maximum efficiency based on the Steinmetz's motor characteristics calculation. The motor operation cost can drastically be reduced

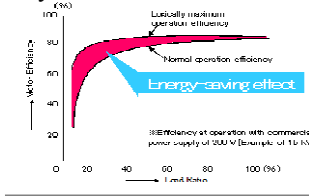

More Energy Saving

The graph below shows the energy required for the operation of air blower control by inverter, and with inverter + energy-saving control.

- With inverter control, power saving from P1 to P2
- With energy-saving control, power saving from P2 to P3

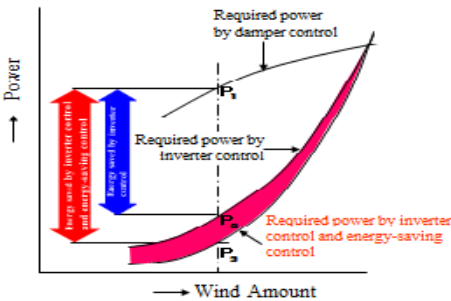

Drive Optimization Corresponds to Load & Temperature changes

- With lighter load, the voltage is reduced to keep up with the efficiency. In case of heavier load, the voltage will increase to maintain a high torque operation.
- The drive will search for optimum drive point automatically, even though the electrical and mechanical characters of the motor or machine changed during the operation. It helps to prolong the life of motor due to the influence of temperature.

Slip - Torque - Efficiency Character

Motor: 380V 7.5kW 4P

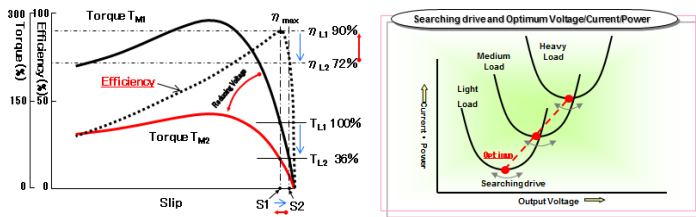

Capable of Driving Induction & Synchronous

- Not only driving induction motor but also synchronous motor and with just one parameter change

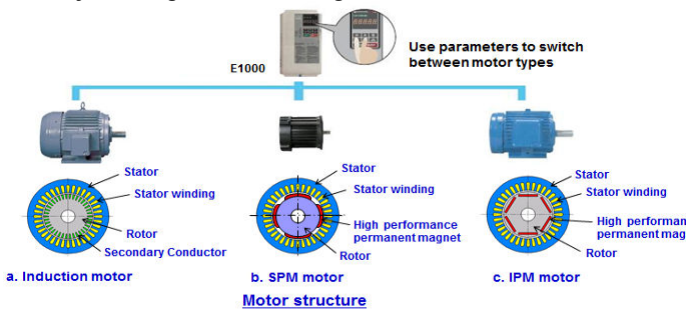

Synchronous Motors Is More Efficient Drive Than High Efficient Induction motors

- Even though high efficiency induction motor has good performance at rated speed and rated load, but synchronous motor has the best performance on all speed range and load condition

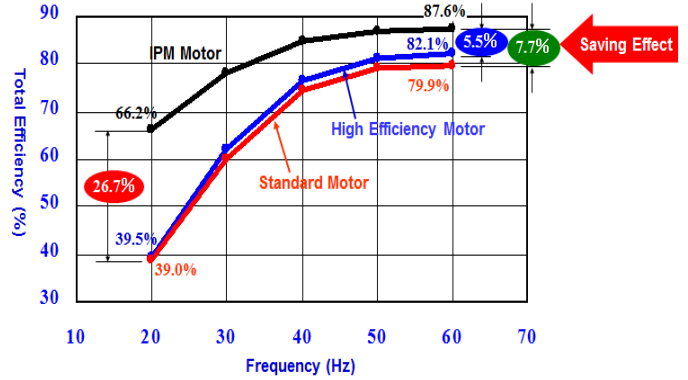

Frequency - Total Efficiency (200V 3.7kW)

Drive constant torque compressor with high efficiency. (IM & SM)

- With auto torque boost function, it can start constant torque compressor easily.
- Even with load fluctuation, the hunting prevention control can maintain the machine stability

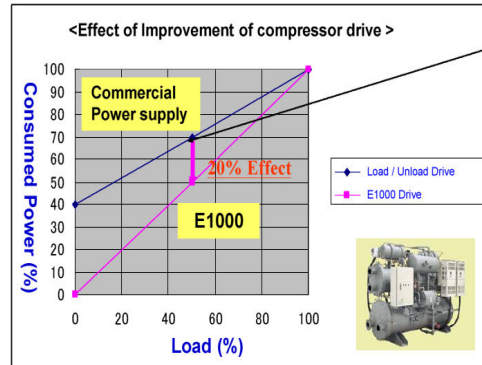

Energy saving effect improves so that load is light e.g. Load is 50% → 20% energy saving is available

Control stable pressure and high efficiency for constant torque compressor

- Optimum drive by energy saving control and overshoot suppression.
- High performance PID control function can prevent pressure and power fluctuation, and thus maintain stable operation.

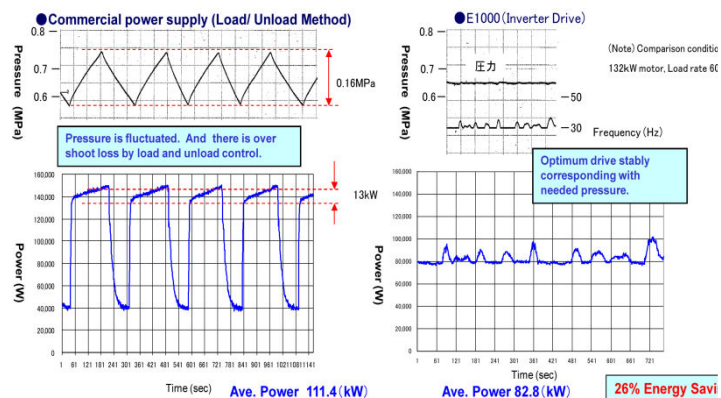

E

Ease Of Operation & Compliance with Environmental

Built-In Energy-Saving Control With Auto-Tuning Function

- Induction motors and synchronous motors have built-in Auto-Tuning function to achieve the highest performance levels possible

Type of Auto-Tuning Functions

Rotational Auto-Tuning	Applications requiring high starting torque, high speed, and high accuracy.
Stationary Auto-Tuning	Applications where the motor must remain connected to the load during the tuning process.
Line-to-Line Resistance	For re-tuning after the cable length between the motor and drive has changed, or when motor and drive capacity ratings differ.

Tackling Power Lost and Recovery

- E1000 offers two ways to handle momentary power loss
- E1000 is capable of handling momentary power loss for induction motors as well as synchronous motors—without the use of a motor encoder

● Speed Search

Easily find the speed of a coasting motor for a smooth restart.

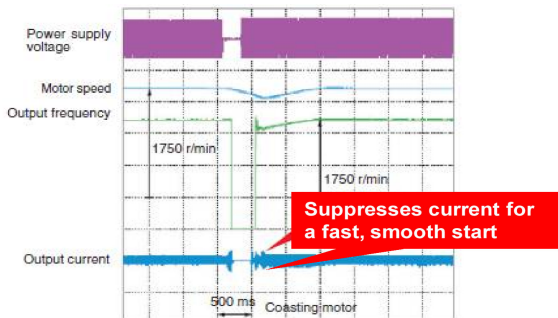

● KEB

Keep the motor running without allowing it to coast.

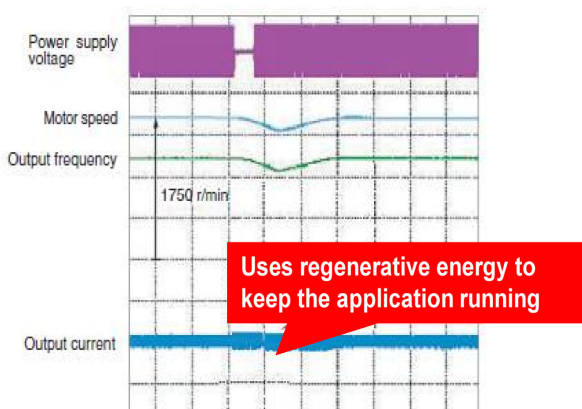

Note: Requires a separate sensor to detect power loss. The drive may trip depending on load conditions, and the motor coast to stop.

Environmental Features

- A variety of protective designs are available to reinforce the drive against moisture, dust, and other harsh environments.

CE, UL / cUL & RoHS Compliance

- All standard products are fully compliant with the CE, UL/ cUL & EU's RoHS directive.

RoHS Compliance

Noise Reduction

- E1000 uses Yaskawa's Swing PWM function* to suppress electromagnetic and audible motor noise, creating a more peaceful environment

● Comparing our former product line with our new Swing PWM feature

■ Former ■

■ E1000 ■

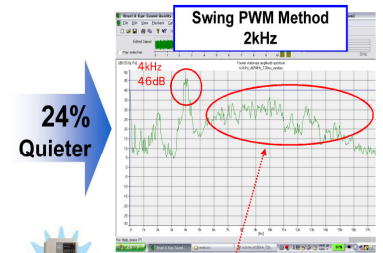
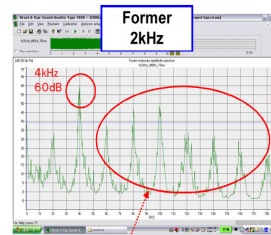

24% Quieter

Suppressing Power Supply Harmonics

- A DC reactor minimizes harmonic distortion, standard on drives 30 kW and above

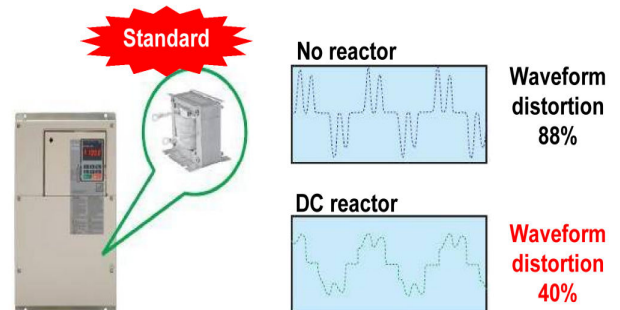

High Performance I/O Function

4-20mA output available

Integrated Power Consumption Monitor

- In addition to monitoring the power, it can monitor the total power consumption
- It can output to a multifunction pulse signal to host PLC
- By using the optional communication module, you can monitor these values

E

Ease Of Operation & Compliance with Environmental

Easy Maintenance

Engineering Tool DriveWizard Plus*

- Manage the unique settings for all your drives right on your PC
- An indispensable tool for drive setup and maintenance. Edit parameters, access all monitors, create customized operation sequences, and observe drive performance with the oscilloscope function
- The Drive Replacement feature in DriveWizard Plus saves valuable time during equipment replacement and application upgrades by converting previous Yaskawa product parameter values to the new E1000 parameters automatically
- USB for connecting to a PC



•USB port lets the drive connect to a PC

Note: Drives are also equipped with an RJ-45 comm. port that takes the existing WV103 cable used in Yaskawa's previous models. Simply remove the operator keypad for to the RJ-45 connector

Simplify for the drive setup and maintenance

- Standard LED Digital operator has copy function. It can Up/Down constants easily. You can use and extend standard LAN cable on the market
- LCD digital operator is option
- Option USB copy unit can copy parameters too
- Setup mode can set the minimum parameters for drive easily
- Verify mode can confirm the changed parameters easily



•LCD operator (Option)



•LED operator (Standard)



•USB copy unit (Option)

•Verify Menu example Changed Value

Name	Parameter	Default	Set Value
Frequency Ref. Selection1	b1-01	1	0
Acceleration Time1	C1-01	10.00 s	15.00 s
Deceleration Time1	C1-02	10.00 s	15.00 s
...

Customization of drive to user requirements

DriveWorksEZ visual programming tool with all models

Simply drag and drop icons to completely customize your drive

Create special sequences and detection functions, then load them onto the drive

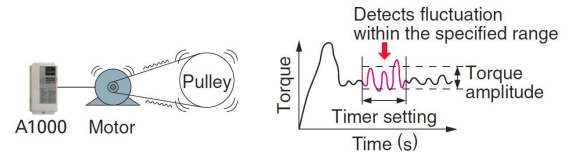

Breeze-Easy Setup

➤ Immediate setup with Application Presets

E1000 automatically sets parameters needed for most major applications. Simply selecting the appropriate application instantly optimizes the drive for top performance, saving enormous time setting up for a trial run.



Example using Application Presets

- Several Application Presets are available to facilitate drive setup for Fan and pump applications.



Setting	Application
00	General-purpose
01	Water Supply Pump
03	Exhaust Fan
04	HVAC Fan

All Major Serial Communication Protocol

- RS-422/485 (MEMOBUS/Modbus) standard on all models
- Option cards available for all major serial networks used across the globe: PROFIBUS-DP*, DeviceNet*, CC-Link*, CANopen*, LONWORKS*, MECHATROLINK-II*, among others
* Available soon
Note: Registered trademarks of those companies.
- Less wiring and space-saving features make for easy installation and maintenance



Safety & High Reliability

Safe Environment

Controlled Stop Despite Power Loss

- Should a power outage occur, E1000 can bring the application to controlled stop quickly and safely using the KEB function.*

Quickly ramp to stop with KEB function

Previous Models

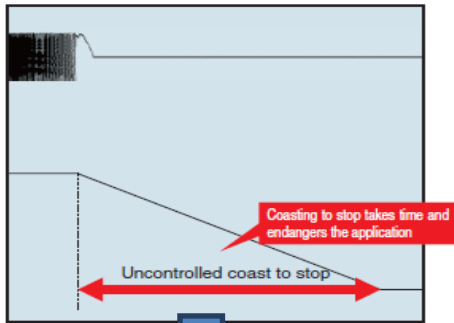

[E1000]

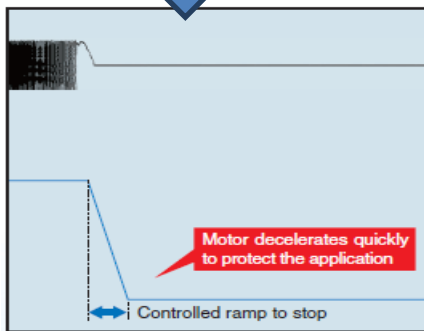

Longer Life Components Design

Ten Years of Durable Performance

- Cooling fan, capacitors, relays, and IGBTs have been carefully selected and designed for a life expectancy up to ten years.*

*Assumes the drive is running continuously for 24 hours a day at 80% load with an ambient temperature of 40°C.

Components Performance Life Monitors

- By Life judgment Forecast Function, alarm signal can output beforehand at the maintenance time (standard) of longevity parts.
 - Digital Operator can monitoring the operation time, number of run command, peak current, overload and degradation parts condition.
- Resisted Temperature design

(Left: Former, Right: Optimum design)

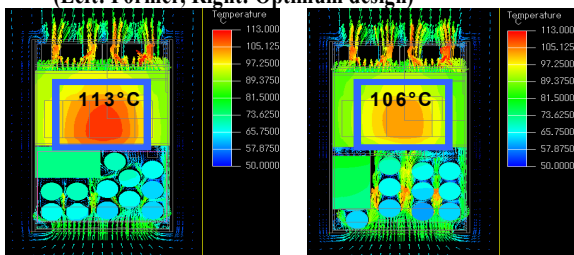

Easy Replacement

World's First Terminal Board with a Parameter Back-Up Function

- The terminal block's ability to save parameter setting data make it a breeze to get the application back up online in the event of a failure requiring drive replacement.

E1000 Terminal Block



Name	Number	Setting
Access Level Selection	A1-02	0
Frequency Reference Selection 1	b1-01	1
Run Command Selection 1	b1-02	1

- Less dust and easy maintenance with top mounted fan design



Machine Protection

Over torque & Under torque can be detected

- It can be detected without expensive mechanical detection system.
- It can be set for each dimension.

Continuous Running

Continuous Operation at Reference Frequency Loss

- If reference frequency is lost during operation, Operation can be still be continued. (This function is selected by parameter)



Standard Specification

400V Class (Three Phase)

Type		Specifications													
Model: CIMR-E□4A		0009	0011	0018	0023	0031	0038	0044	0058	0072	0088	0103	0139	0165	0208
Max. Applicable Motor Capacity(KW) <1>		3.7	5.5	7.5	11	15	18.5	22	30	37	45	55	75	90	110
Input	Rated Input Current (A) <2>	9.4	14	20	24	38	44	52	58	71	86	105	142	170	207
Output	Rated Output Capacity (KVA) <3>	6.7	8.5	13.3	17.5	24	29	34	44	55	67	78	106	126	159
	Rated Output Current(A) <4>	8.8	11.1	17.5	23	31	38	44	58	72	88	103	139	165	208
	Overload Tolerance	120% of rated output current for 60 s													
	Carrier Frequency	1 ~15kHz (Carrier frequency can be set by the user)													
	Max. Output Voltage(V)	Three-Phase 380 ~ 480V (Relative to Input Voltage)													
Max. Output Frequency(Hz)		400Hz (User-set)													
Power	Rated Voltage / Rated Frequency	AC: Three-Phase 380 ~ 480V 50/60Hz DC: 510 ~ 680V													
	Allowable Voltage Fluctuation	-15 ~ 10%													
	Allowable Frequency Fluctuation	±5%													
	Power Supply (KVA)	10.0	14.5	19.4	28.4	37.5	46.6	54.9	53.0	64.9	78.6	96	106	126	159

Type		Specifications						
Model: CIMR-E 4A		0250	0296	0362	0414	0515	0675	
Max. Applicable Motor Capacity(KW) <1>		132	160	185	220	250	355	
Input	Rated Input Current (A) <2>	248	300	346	410	465	657	
Output	Rated Output Capacity (KVA) <3>	191	226	276	316	392	514	
	Rated Output Current(A) <4>	250	296	362	414	515	675	
	Overload Tolerance	120% of rated output current for 60 s (Note: Derating may be required for applications that start and stop frequently)						
	Carrier Frequency	1 ~10kHz (Carrier frequency can be set by the user)			1 ~5kHz (Carrier frequency can be set by the user)			
	Max. Output Voltage(V)	Three-Phase 380 ~ 480V (Relative to Input Voltage)						
Max. Output Frequency(Hz)		200Hz (User-set)			150Hz (User-set)			
Power	Rated Voltage / Rated Frequency	AC: Three-Phase 380 ~ 480V 50/60Hz DC: 510 ~ 680V						
	Allowable Voltage Fluctuation	-15 ~ 10%						
	Allowable Frequency Fluctuation	±5%						
	Power Supply (KVA)	191	226	276	316	392	514	

- <1> Based on motor data of Yaskawa 4-pole, 60Hz standard motors. Motor rated current should not exceed the drive rated output current.
- <2> Value shown is for when operating at the rated output current. This value may fluctuate based on the power supply side impedance, as well as the input current.
- <3> Value displayed is for when operating at the rated output current. Rated output capacity is calculated with a rated output voltage of 440V.
- <4> Increasing the carrier frequency requires a reduction in current.

Model Designations

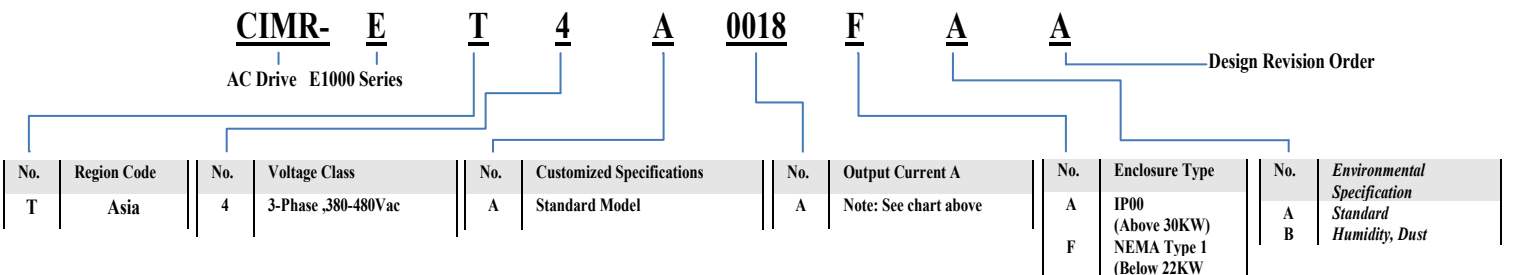



Common Specification

Item		Specifications
Control Characteristics	Control Method	The following control methods can be set using drive parameters: <ul style="list-style-type: none"> • V/f Control (V/f) • Open Loop Vector Control for PM (OLV/PM)
	Frequency Control Range	0.01 to 200 Hz
	Frequency Accuracy (Temperature Fluctuation)	Digital input: within $\pm 0.01\%$ of the max. output frequency (-10 to + 40°C) Analog input: within $\pm 0.1\%$ of the max. output frequency (25°C \pm 10°C)
	Frequency Setting Resolution	Digital input: 0.01Hz Analog input: 0.03 Hz / 60 Hz (11 bit)
	Output Frequency Resolution	0.001 Hz
	Frequency Setting Signal	-10 to 10 V, 0 to 10 V, 0 to 20 mA, Pulse Train Input
	Starting Torque	V/f: 150% at 3 Hz OLV/PM: 100% at 5% speed
	Speed Control Range	V/f: 1:40 OLV/PM: 1:20
	Speed Response	OLV/PM: 10 Hz
	Accel/Decel Time	0.00 to 6000.0s (4 selectable combinations of independent acceleration and deceleration settings)
	Braking Torque	Approximately 20% <1>
	V/f Characteristics	User-selected programs and V/f preset patterns possible
Main Control Functions	Momentary Power Loss Ride-Thru, Speed Search, Overtorque/Undertorque Detection, 8 Step Speed (max), Accel/decel Switch, S-curve Accel/decel, 3-wire Sequence, Auto-turning, Dwell, Cooling Fan on/off Switch, Slip Compensation, Torque Compensation, Frequency Jump, Upper/lower Limits for Frequency Reference, DC Injection Braking at Start and Stop, Overexcitation Braking, High Slip Braking, PI Control (with sleep function or snooze function), Energy Saving Control, MEMOBUS/Modbus Comm. (RS-422/RS-485 max, 115.2 kbps), Fault Restart, DriveWorksEZ (customized function), Removable Terminal Block with Parameter Backup Function, KEB, Overexcitation Deceleration, Overvoltage Suppression, Motor Underload Detection, etc.	
Protection Function	Motor Protection	Electronic thermal overload relay
	Momentary Overcurrent Protection	Drive stops when output current exceeds 175%
	Overload Protection	Drive stops after 60 s at 120% of rated output current <2>
	Overvoltage Protection	400 V class: Stops when DC bus exceeds approx. 820V
	Undervoltage Protection	400 V class: Stops when DC bus exceeds approx. 380V
	Momentary Power Loss Ride-Thru	Immediately stop after 15 ms or longer power loss. <3> Continuous operation during power loss to 2 s (standard) <4>
	Heatsink Overheat Protection	Thermistor
	Stall Prevention	Stall prevention is available during acceleration, deceleration, and during run.
	Ground Protection	Electronic circuit protection <5>
	DC Bus Charge LED	Remains lit until DC bus voltage falls below 50V
Environment	Area of Use	Indoors
	Ambient Temperature	-10 to 40°C (NEMA Type 1 enclosure), -10 to 50°C (IP00 enclosure), up to 60°C with output current derating
	Humidity	95 RH% or less (no condensation)
	Storage Temperature	-20 to 60°C (short-term temperature during transportation)
	Altitude	Up to 1000 meters <6>
	Shock	10 to 20 Hz: 9.8 m/s ² <7> 20 to 55Hz : 5.9 m/s ² (4A0002 to 4A1200)
Protection Design	IP00 enclosure, IP20/NEMA Type 1 enclosure <8>	

<1> Ensure that Stall Prevention is disabled during deceleration (L3-04 = 0), when using a regenerative converter, a regenerative unit. The default setting for the Stall Prevention function will interfere with the braking resistor

<2> Overload protection may be triggered when operating with 120% of the rated output current if the output frequency is less than 6 Hz.

<3> May be shorter due to load conditions and motor speed

<4> A separate Momentary Power Loss Ride-Thru Unit is required for the drives CIMR-E□2A0004 through 2A0056 and 4A0002 through 4A0031 if the application needs to continue running during a momentary power loss up to 2 s.

<5> Ground protection cannot be provided when the impedance of the ground fault path is too low, or when the drive is powered up while a ground fault is present at the output.

<6> Up to 3000 m with output current and voltage derating.

<7> Models CIMR-E□4A0930 and 4A1200 are rated at 5.9 m/s²

<8> Removing the top protective cover from a NEMA Type 1 enclosure drive voids the NEMA Type 1 protection but still keeps IP20 conformity. This is applicable to models CIMR-E□4A0002 to 4A0044.



Standard Connection Diagram

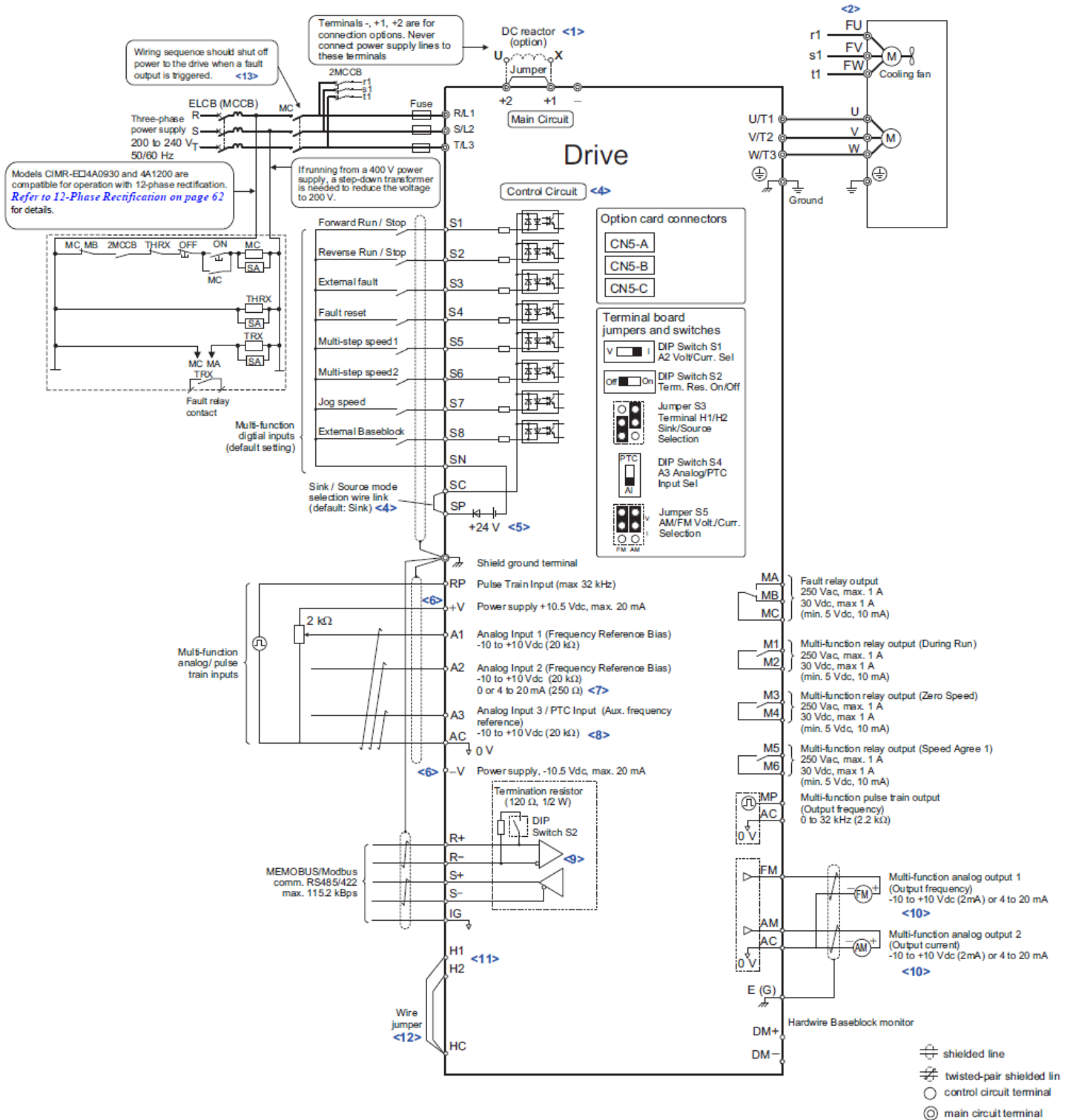

- <1> Remove the jumper when installing a DC reactor. Models CIMR-E□4A0058 through 4A1200 come with a built-in DC reactor.
- <2> Self-cooling motors do not require wiring that would be necessary with motors using a cooling fan.
- <3> Supplying power to the control circuit separately from the main circuit requires a 24 V power supply (option).
- <4> This figure shows an example of a sequence input to S1 through S8 using a non-powered relay or an NPN transistor. Install the wire link between terminals SC-SP for Sink mode and SC-SN for Source mode. Leave it out for external power supply. Never short terminals SP and SN as doing so will damage the drive.
- <5> The maximum current supplied by this voltage source is 150 mA.
- <6> The maximum output current capacity for the +V and -V terminals on the control circuit is 20 mA. Never short terminals +V, -V, and AC, as this can cause erroneous operation or damage the drive.
- <7> Set DIP switch S1 to select between a voltage or current input signal to terminal A2. The default setting is for current input.
- <8> Set DIP switch S4 to select between analog or PTC input for terminal A3.
- <9> Enable the termination resistor in the last drive in a MEMOBUS network by setting DIP switch S2 to the ON position.
- <10> Monitor outputs work with devices such as analog frequency meters, ammeters, voltmeters, and wattmeters. They are not intended for use as a feedback-type of signal.
- <11> Use jumper S3 to select between Sink Mode, Source Mode or External Power supply for Hardwire Baseblock Inputs.
- <12> Disconnect the wire jumper between H1-HC, H2-HC when utilizing the Hardwire Baseblock Inputs.
- <13> Note that if the drive is set to trigger a fault output whenever the fault restart function is activated (L5-02 = 1), then a sequence to interrupt power when a fault occurs will result in shutting off the power to the drive as the drive attempts to restart itself. The default setting for L5-02 is 0 (fault output not active during restart attempt).

E

External Dimension

Enclosure Type (NEMA Type 1/IP20)

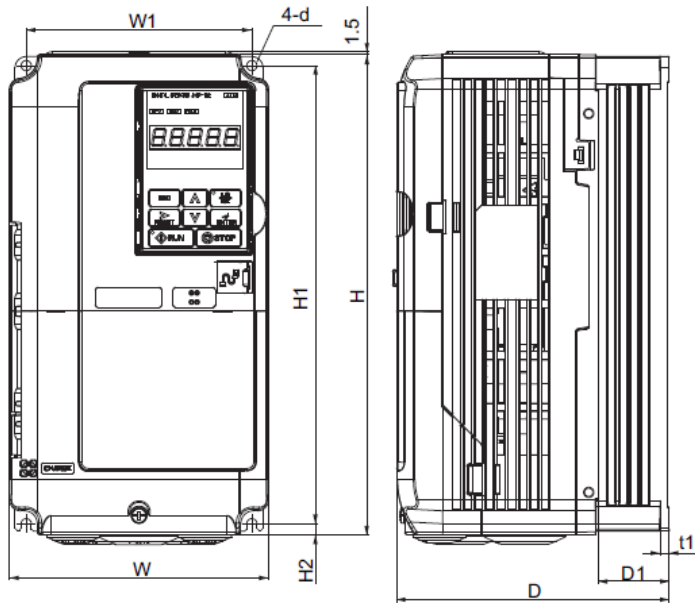

Figure 1

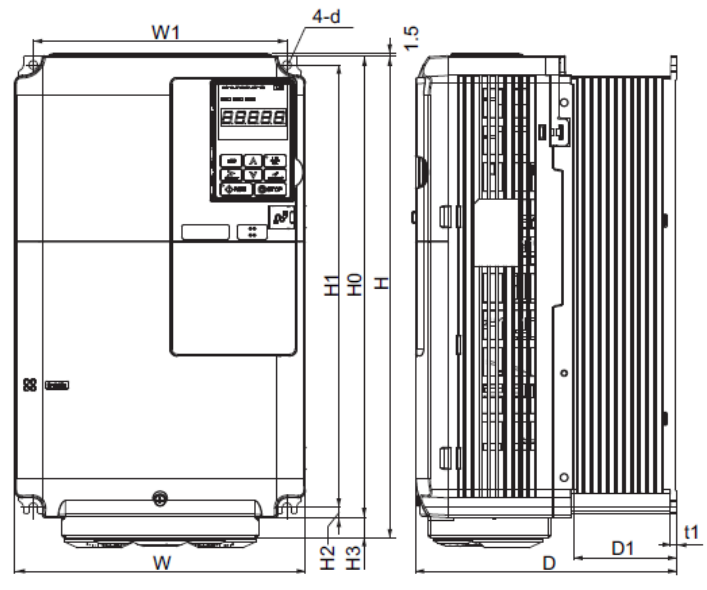

Figure 2

Table 2.5 Dimensions for IP20/NEMA Type 1 Enclosure: 400 V Class

Drive Model CIMR-E□4A	Dimensions (mm)													
	Figure	W	H	D	W1	H0	H1	H2	H3	D1	t1	t2	d	Weight (kg)
0002	1 <1>	140	260	147	122	–	248	6	–	38	5	–	M5	3.2
0004		140	260	147	122	–	248	6	–	38	5	–	M5	3.2
0005		140	260	147	122	–	248	6	–	38	5	–	M5	3.2
0007		140	260	164	122	–	248	6	–	55	5	–	M5	3.4
0009		140	260	164	122	–	248	6	–	55	5	–	M5	3.5
0011		140	260	164	122	–	248	6	–	55	5	–	M5	3.5
0018		140	260	167	122	–	248	6	–	55	5	–	M5	3.9
0023		140	260	167	122	–	248	6	–	55	5	–	M5	3.9
0031		180	300	167	160	–	284	8	–	55	5	–	M5	5.4
0038		180	300	187	160	–	284	8	–	75	5	–	M5	5.7
0044	220	350	197	192	–	335	8	–	78	5	–	M6	8.3	
0058	3 <2>	254	465	258	195	400	385	7.5	65	100	2.3	2.3	M6	23
0072		279	515	258	220	450	435	7.5	65	100	2.3	2.3	M6	27
0088		329	630	258	260	510	495	7.5	120	105	2.3	3.2	M6	39
0103		329	630	258	260	510	495	7.5	120	105	2.3	3.2	M6	39
0139		329	730	283	260	550	535	7.5	180	110	2.3	2.3	M6	45
0165		329	730	283	260	550	535	7.5	180	110	2.3	2.3	M6	46
0208		456	960	330	325	705	680	12.5	255	130	3.2	3.2	M10	87
0250		504	1168	350	370	800	773	13	368	130	4.5	4.5	M12	106
0296		504	1168	350	370	800	773	13	368	130	4.5	4.5	M12	112
0362		504	1168	350	370	800	773	13	368	130	4.5	4.5	M12	117

<1> Removing the top protective cover from a IP20/NEMA Type 1 drive voids NEMA Type 1 protection but still keeps IP20 conformity.
 <2> Special order required. Contact your Yaskawa sales representative.

Enclosure Type (IP00)

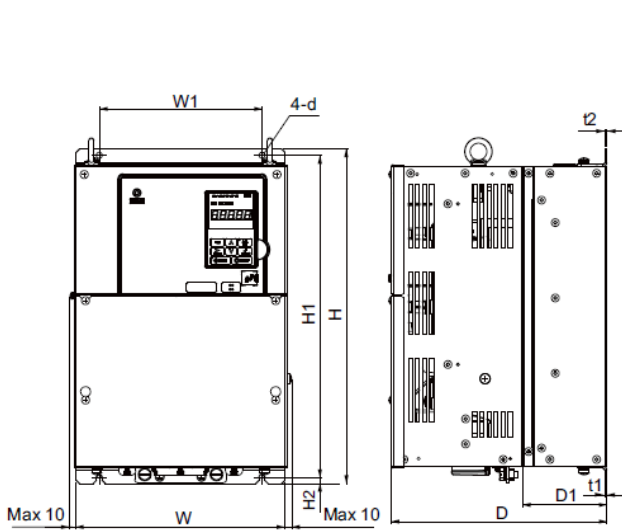

Figure 1

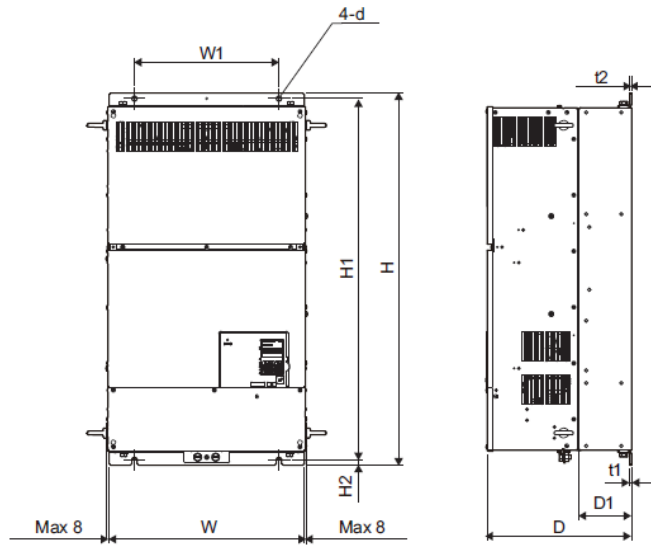

Figure 2

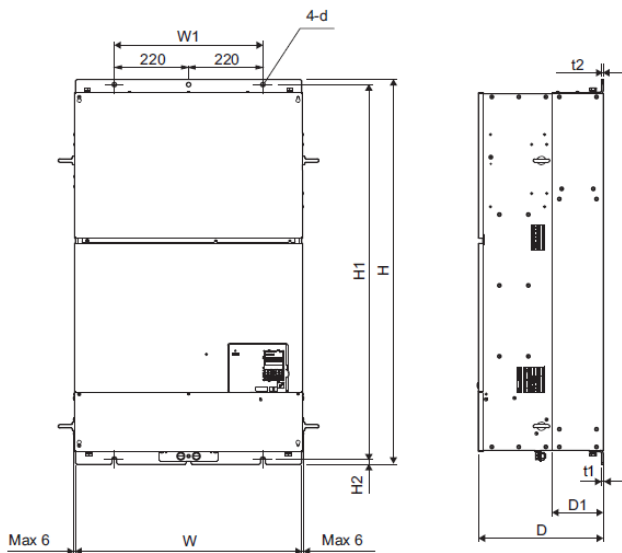

Figure 3

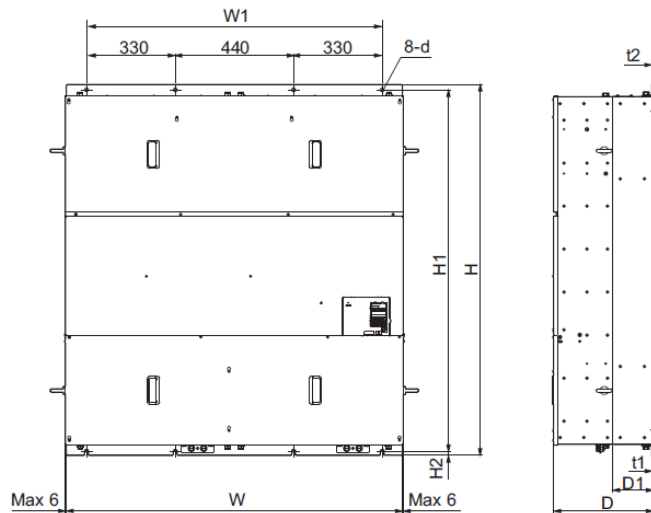



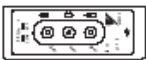



Figure 4

Table 2.7 Dimensions for IP00 Enclosure: 400 V Class

Drive Model CIMR-E□4A	Dimensions (mm)											Weight (kg)
	Figure	W	H	D	W1	H1	H2	D1	t1	t2	d	
0058	1	250	400	258	195	385	7.5	100	2.3	2.3	M6	21
0072		275	450	258	220	435	7.5	100	2.3	2.3	M6	25
0088		325	510	258	260	495	7.5	105	2.3	3.2	M6	36
0103		325	510	258	260	495	7.5	105	2.3	3.2	M6	36
0139		325	550	283	260	535	7.5	110	2.3	2.3	M6	41
0165		325	550	283	260	535	7.5	110	2.3	2.3	M6	42
0208		450	705	330	325	680	12.5	130	3.2	3.2	M10	79
0250		500	800	350	370	773	13	130	4.5	4.5	M12	96
0296		500	800	350	370	773	13	130	4.5	4.5	M12	102
0362		500	800	350	370	773	13	130	4.5	4.5	M12	107
0414	2	500	950	370	370	923	13	135	4.5	4.5	M12	125
0515	3	670	1140	370	440	1110	15	150	4.5	4.5	M12	216
0675		670	1140	370	440	1110	15	150	4.5	4.5	M12	221
0930	4	1250	1380	370	1110	1345	15	150	4.5	4.5	M12	545
1200		1250	1380	370	1110	1345	15	150	4.5	4.5	M12	555

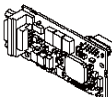
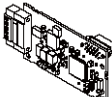
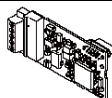
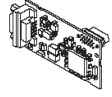
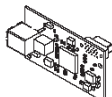

Peripherals Devices & Options

Option	Model Number	Description	
Interface Options			
	LCD Operator	JVOP-180	Digital operator with 8 languages, clear text LCD display, and copy function; max. cable length for remote usage: 3m
	Remote Operator Cable	WV001/WV003	Extension cable (1m or 3m) to connect the digital operator for remote operation RJ-45, 8 pin straight through, UTP CAT5e cable
	USB Copy Unit	JVOP-181	Allows the user to copy and verify parameter settings between drives. Can also be used as an adapter to connect the drive to the USB port on a PC.
Attachment			
-	Attachment for External Heatsink	EZZ020786	Installation kit for mounting the drive with the heatsink outside of the panel (Side-by-Side mounting possible)
-	NEMA 1 Kit	EZZ020787	Parts to make the drive conform to NEMA Type 1 enclosure requirements
	Installation Support Set A	EZZ020642A	For installing the digital operator keypad on the outside of an enclosure panel that houses the drive. Uses screws to secure the operator.
	Installation Support Set B	EZZ020642B	For installing the digital operator keypad on the outside of an enclosure panel that houses the drive. Uses nuts to secure the operator for installations where screws are not practical.
Others			
	24 V Power Supply	200 V class: PS-A 10LB 400 V class: PS-A 10HB	Provides power to the control circuit and option boards in the event of power loss. Allows the user to still monitor drive settings and fault information even if the main circuit has no power.
-	DriveWizard Plus	-	PC tool for drive setup and parameter management.
-	DriveWorksEZ	-	PC tool for enhanced programming of the drive
Communication Options			
	PROFIBUS-DP	SI-P3 *	Connects to a PROFIBUS-DP network
	CC-Link	SI-C3 *	Connects to a CC-Link network
	DeviceNet	SI-N3 *	Connects to a DeviceNet network
	CANopen	SI-S3 *	Connects to a CANopen network
	MECHATROLINK-II	SI-T3 *	Connects to a MECHATROLINK-II network

*Under development

E

Peripherals Devices & Options

- 24V POWER SUPPLY**

The 24 V Power Supply Option maintains drive control circuit power in the event of a main power outage. The control circuit keeps the network communications and I/O data operational in the event of a power outage. It supplies external power to the control circuit only.

Note: Parameter settings cannot be changed when the drive is operating solely from this powers supply.

The installed option adds 50mm to the total depth of the drive.

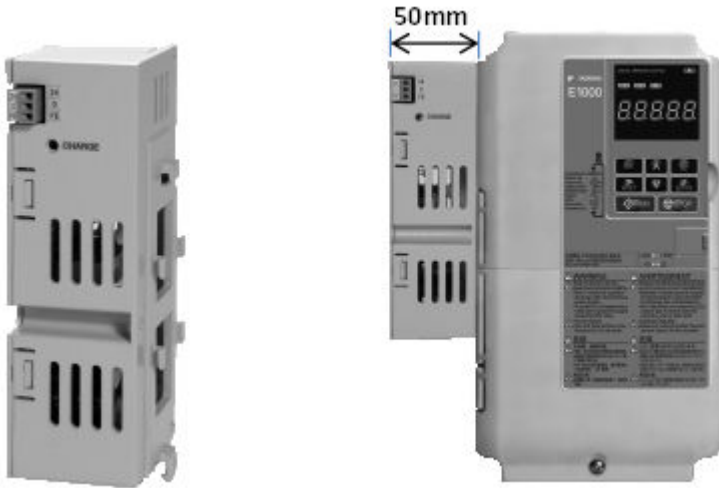

Connection Diagram

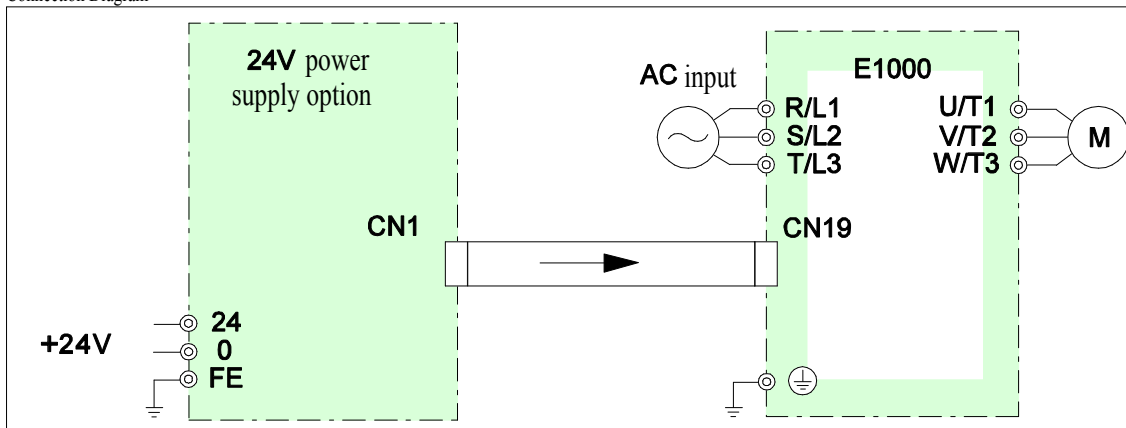

Model	Code No.
400V: PS-A10H	PS-A10H

Note: For motors (400V) with capacity of 96V or more, use this unit (as a backup power source) in the event of a power loss.

E

Peripherals Devices & Options

- Fuse / Fuse Holder**

Yaskawa recommends installing a fuse to the input side of the drive to prevent damage to the drive if a short circuit occurs.

Select the appropriate fuse from the table below.

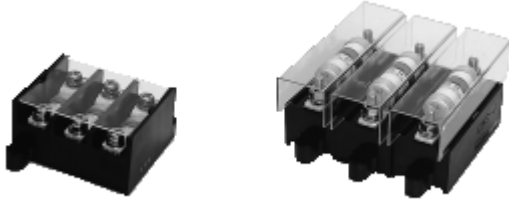

[Fuji Electric FA Components & Systems Co., Ltd]

400V Class

Model CIMR-E <input type="checkbox"/>	Fuse		Fuse Holder	
	Manufacturer: Fuji Electric			
	Model	Rated Current (A)	Model	Qty
4A0002	CR6L-20	20	CMS-4	3
4A0004	CR6L-30	30	CMS-4	3
4A0005	CR6L-50	50	CMS-4	3
4A0007	CR6L-50	50	CMS-4	3
4A0009	CR6L-50	50	CMS-4	3
4A0011	CR6L-50	50	CMS-4	3
4A0018	CR6L-75	75	CMS-5	3
4A0023	CR6L-75	75	CMS-5	3
4A0031	CR6L-100	100	CMS-5	3
4A0038	CR6L-150	150	CMS-5	3
4A0044	CR6L-150	150	CMS-5	3
4A0058	CR6L-200	200	-	-
4A0072	CR6L-250	250	-	-
4A0088	CR6L-250	250	-	-
4A0103	CR6L-300	300	-	-
4A0139	CR6L-350	350	-	-
4A0165	CR6L-400	400	-	-
4A0208	CS5F-600	600	-	-
4A0250	CS5F-600	600	-	-
4A0296	CS5F-600	600	-	-
4A0362	CS5F-800	800	-	-
4A0414	CS5F-800	800	-	-
4A0515	CS5F-800	800	-	-
4A0675	CS5F-1000	1000	-	-
4A0930	CS5F-1200	1200	-	-
4A1200	CS5F-1500	1500	-	-

Note: Required UL/CE certification, kindly refers to user guide for details.



Contact Details

Yaskawa Electric (Singapore) Pte Ltd

Headquarter:

151 Lorong Chuan, #04-02A New Tech Park Singapore 556741

Tel: +62 6282 3003

Fax: +62 6289 3003

Yaskawa Electric (Thailand) Co., Ltd

252/246, 4th Floor, Muang Thai-Phatra office Tower 2,
Rachadaphisek Road, Huaykwang, Bangkok 10320, Thailand

Tel: +66 2 693 2200

Fax: +66 2 693 4200

PT. Yaskawa Electric Indonesia

Menara Anugrah Lantai 1, Kantor Taman E.3.3

Jl. Mega Kuningan Lot 8.6-8.7 Kawasan Mega Kuningan

Jakarta 12950 Indonesia

Tel: +62 21 5794 1845

Fax: +62 21 5794 1843

Yaskawa Electric (Singapore) Pte Ltd – Vietnam Representative Office

31/F-S35 Saigon Trade Center,

#37 Ton Duc Thang Street, Ben Nghe Ward, District 1,

Ho Chi Minh City, Vietnam

Tel: +84 8 39110280

Fax: +84 8 39100082



YASKAWA

In the event that the end user of this product is to be the military and said product is to be employed in any weapons systems or the manufacture thereof, the export will fall under the relevant regulations as stipulated in the Foreign Exchange and Foreign Trade Regulations. Therefore, be sure to follow all procedures and submit all relevant documentation according to any and all rules, regulations and laws that may apply.

Specifications are subject to change without notice for ongoing product modifications and improvements.